

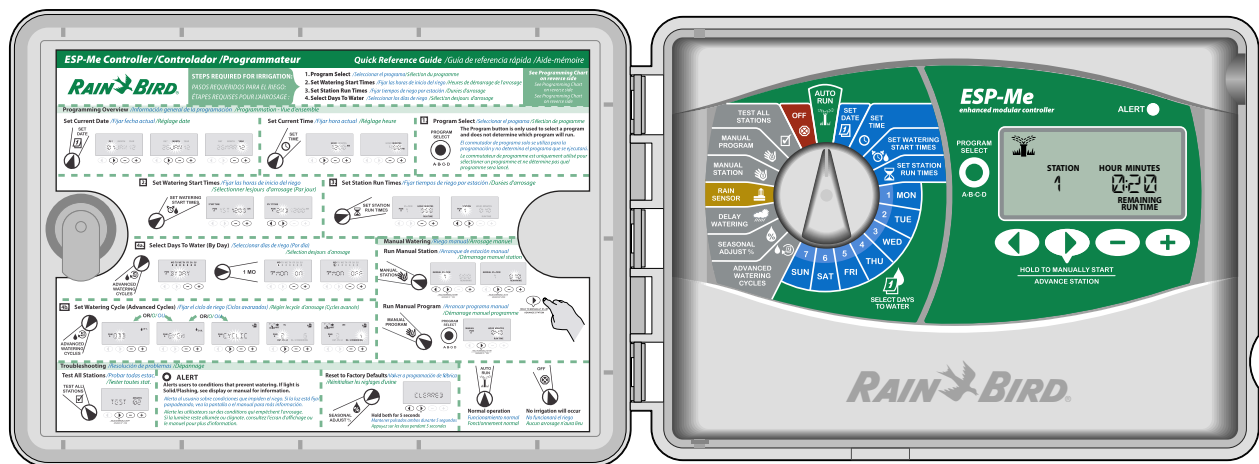







ESP-Me enhanced modular controller

Advanced User Manual





Symbols

-  **CAUTION:** Symbol is intended to alert the user to important instructions or conditions that could seriously affect irrigation effectivity or controller operation.
-  **DIAL:** Symbol indicates that the user is required to turn the dial on the controller to the appropriate position in order to follow subsequent instructions as described in that section.
-  **NOTE:** Symbol is intended to alert the user to important operating functionality, installation or maintenance instructions.
-  **REPEAT:** Symbol indicates that a repetition of previous steps or may be required in order to continue or complete the controller programming process.
-  **SPECIAL FEATURE AVAILABLE:** Symbol indicates that a Special Feature is available for the dial position. For more details see the Special Features section of the Advanced User Manual.
-  **WARNING:** Symbol alerts the user to the presence of electricity or electromagnetic energy which may constitute a risk of electric shock, radiation exposure or other hazard.

Safety Information

-  **WARNING:** Date and time are retained by a lithium battery which is to be disposed of in accordance with local regulations.
-  **WARNING:** Use only Rain Bird approved accessory devices. Unapproved devices may damage controller and void warranty. For a list of compatible devices go to: www.rainbird.com/controllersupport

 **WARNING:** You must use special precautions when valve wires (also known as station or solenoid wires) are located adjacent to or share a conduit with other wires, such as wires used for landscape lighting, other “low voltage” systems or other “high voltage” power. Be sure to separate and insulate all conductors carefully taking care not to damage wire insulation during installation. An electrical “short” (contact) between the valve wires and another source of power can damage the controller and create a fire hazard.

 **NOTE:** This appliance is not intended for use by persons (including children) with reduced physical, sensory or mental capabilities, or lack of experience and knowledge, unless they have been given supervision or instruction concerning use of the appliance by a person responsible for their safety.

Children should be supervised to ensure that they do not play with the appliance.

Disposal of Electronic Waste



In compliance with European Directive 2002/96/CE and EURONORM EN50419:2005, this device must not be thrown away with household garbage. This device must be the object of an appropriate, selective removal procedure in order to recuperate it.

Questions?

In the USA or Canada call Rain Bird Technical Support at 1-800-724-6247 or visit our web site at www.rainbird.com/controllersupport

Contents

Questions?	II
Check Box Contents.....	IV
Introduction	
Welcome to Rain Bird	1
The ESP-Me Controller	1
Controller Features.....	1
Station Expansion Modules	2
Module Options.....	2
Controls and Indicators.....	2
Programming Overview	3
Controller Definitions.....	3
Programming Chart	3
Display Legend	4
Normal Operation	
Auto Run	5
Off	5
Basic Operation	
Set Date	6
Set Time.....	6
Program Select.....	6
Set Watering Start Times.....	7
Set Station Run Times.....	7
Select Days to Water	
Introduction and Overview	8
Watering Options.....	8
By Day (Custom)	8
Advanced Cycles	9
Odd Days.....	9
Even Days.....	9
Cyclic Days.....	10
Advanced Options	
Seasonal Adjust	11
Delay Watering	12
Rain Sensor	12
Manual Watering Operations	13
Manual Station	13
Manual Program	14
Total Run Time Calculator	
By Program	15
Test All Stations.....	15
Special Features 	
Overview	16
List of Special Features	16
Delay Between Valves	16
Set Master Valve By Station.....	17
Permanent Days Off	18
Bypass Rain Sensor	
For Any Station.....	18
Additional Features.....	18

Installation	
Installation Checklist.....	19
Gather Installation Tools.....	19
Mount Controller	19
Choose Location.....	19
Remove Front Panel.....	19
Remove Knock-outs.....	20
Mount Controller.....	20
Connect Power	21
Indoor Model	21
Outdoor Model	21
Station Expansion Modules	22
Module Options.....	22
Install Modules	22
Station Numbering.....	23
Module Configuration.....	23
Wiring Connections	24
Connect Valves	24
Connect Master Valve	24
Connect Pump Start Relay.....	25
Connect Optional Rain Sensor	
(Wired or Wireless).....	26
Set Rain Sensor to Active	
(after installing a rain sensor and removing	
jumper wire on backplane)	26
Complete Installation.....	27
Optional Features	
Connect Optional Accessory	28
Remote Programming.....	28
Troubleshooting	
Battery Life	29
Reset Button	29
Error Detection.....	29
Programming Errors (blinking LED)	29
Electrical Errors (non-blinking LED).....	29
Clearing Electrical Error Alerts	29
Frequently Asked Questions.....	30
Electrical Issues (solid LED illuminated)	31

Check Box Contents

- a. ESP-Me Controller (outdoor model shown)
- b. User Manual
- c. Quick Reference Guide/Programming Chart (inside controller door)
- d. Special Features Card(s) depending on model
- e. Mounting Hardware (Wire nuts for outdoor unit only)
- f. Grounded 120V Power Supply (indoor model only)
- g. Door Keys (outdoor model only)

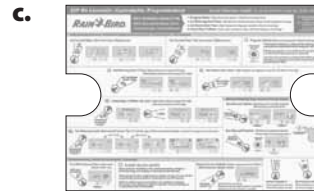

Introduction

Welcome to Rain Bird

Thank you for choosing the ESP-Me Modular Controller from Rain Bird.

For more than 70 years, the world's top irrigation contractors have chosen Rain Bird for the highest quality products and services available worldwide.

The ESP-Me Controller

Your new Rain Bird controller is designed to provide many years of advanced irrigation control.

The indoor model comes with a wall plug-in transformer that can only be used for indoor mounting, while the outdoor model comes with an internal transformer and lead wires for direct wiring to your power source. The outdoor model can be used either outdoor or indoor.

Controller Features

The ESP-Me Controller has a variety of advanced water management features, including:

- The base unit comes standard with 4 stations and is expandable up to 22 stations with 3 or 6 station modules.
- The controller supports a master valve or pump start relay and a rain sensor.

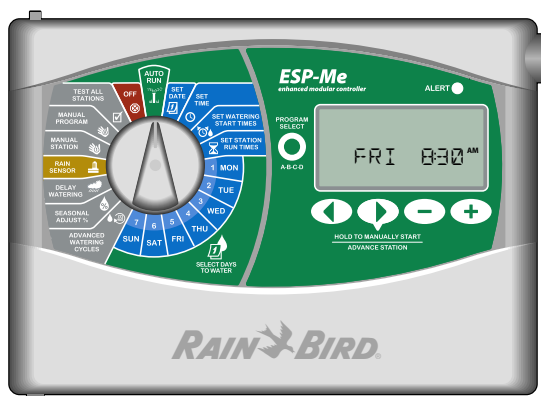

- 4 available programs (A,B,C,D) can be set to water on selected days of the week, odd or even calendar days, or custom intervals (cyclic) to provide flexibility and control of irrigation schedules.

NOTE: Only one program can run at a time.

- 6 start times for each program allow you to run the same program several times a day.
- Automatic alarm alerts indicate when problems such as shorted stations or if incomplete programming exists.
- Seasonal Adjust quickly increases or decreases watering duration based on seasonal weather conditions. Setting can be applied to a specific program or to ALL programs. Range is from 200% down to 5%.
- Delay Watering (Rain Delay) can prevent irrigation for up to 14 days. After the period expires, it resumes scheduled programming.
- Manual Water Station or Program allows immediate watering of an individual station or an entire program.
- Test All Stations verifies proper operation of all the valves in the system.
- Total Run Time Calculator By Program allows you to know what the watering duration will be by program for one start time. Add up all program total run times to determine duration of the entire watering cycle.
- Sensor Bypass by Station allows you to set any station to ignore the rain sensor.
- Hot swappable modules means you don't have to disconnect the power source to install or remove a module.

The following do not require a 9V battery to maintain:



- Date and Time are maintained up to 10 years by an internal Lithium battery.
- Programs and Settings are permanently stored in controllers non-volatile memory.

Station Expansion Modules

Additional Station Modules can increase the number of available stations up to 22.

The ESP-Me Controller comes standard with a base module that supports four stations. If more stations are required, up to three additional Station Modules (not included) can be installed.

NOTE: 6-Station module is compatible only with the ESP-Me. They are not backwards compatible with the previous vintage controller.

Module Options

Base Module (included)



4-STATION

Expansion Modules (sold separately)

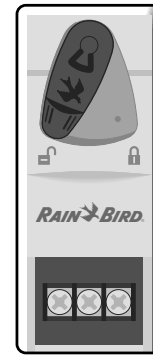

3-STATION (ESPSM3)



6-STATION (ESPSM6)

Controls and Indicators

Key operational features of the ESP-Me Controller:

Programming Dial
Rotate the dial to select programming functions.

Water Start Times
Up to 6 per program

Set Station Run Times
1 minute to 6 hours

Program Select Button
Select Watering Program A, B, C, or D.

Alarm Indicator
Illuminates solid or flashes when an alarm condition exists.

Back/Next Buttons
Select programming options.

- / + Buttons
Adjust program settings. (Press and HOLD - or + to accelerate adjustments).

Hold to Start
Manual irrigation.

Test All Stations

Manual Watering

Rain Sensor
Applies to all programs but can be set to bypass individual stations.

Delay Watering
Up to 14 days.

Seasonal Adjust
Adjust value from 5% up to 200%

Water Day(s) Options
By Day, Odd, Even or Cyclic.

ESP-Me Controller Front Panel

Programming Overview

Controller Definitions

Program

A program is a custom irrigation schedule that controls watering days, start times and run times for each station. Four separate programs are available (A, B, C, and D).

Station

A station corresponds to a valve connected to the controller and is operated according to irrigation schedules.

Watering Start Time

A Watering “Start Time” is the time of day that a program begins to water. Up to six Start Times per day are available.

Station Run Time

A Station “Run Time” is the length of time (for example, 20 minutes) that a station will water. The run times can range from 1 minute up to a maximum of 6 hours.

Select Days to Water

There are four different watering options:

- **By Day (Custom)**

This is the default program option and also the most common. Set watering to occur on specific days of the week by choosing ON or OFF for that day of the week.

Advanced Options

- **Odd Days**

Set watering to occur on all ODD calendar days, for example 1, 3, 5...29

- **Even Days**

Set watering to occur on all even calendar days, for example 2, 4, 6...30

- **Cyclic Days**

Set watering to occur at specific intervals, for example, every 2 days, or every 3 days, etc.

Seasonal Adjust

Increase or decrease watering duration based on seasonal weather conditions.

Rain Delay

Allows prevention of irrigation up to 14 days.

Rain Sensor

Allows the bypass of the rain sensor by program or by station.

Manual Program or Station

Allows user to immediately run a specific program or station.

Valve Test

VT terminal located on base module to be used to identify station. This terminal is always “ON”.

Programming Chart

Before you begin programming, fill out the Programming Chart.

Follow the instructions to create irrigation schedules for each program.

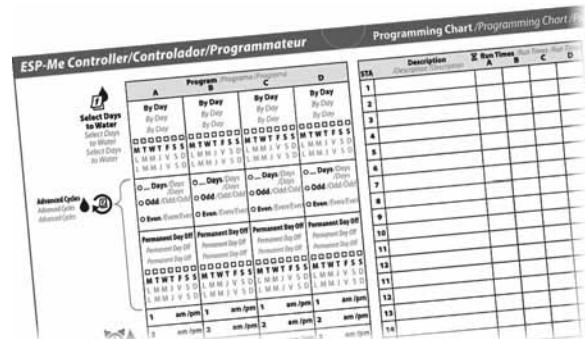

Display Legend

This manual uses USA domestic icons for illustration purposes. The following table lists the differences between the domestic and international display screen symbols. Choose your voltage below to determine the LCD symbols for your controller.

Domestic vs. International Display Symbols

120V & 240V	230V	English
OFF		Off
 NEXT		Next Watering Day
MO	1	Monday
TU	2	Tuesday
WE	3	Wednesday
TH	4	Thursday
FR	5	Friday
SA	6	Saturday
SU	7	Sunday
DAY	DD	Day
MONTH	MM	Month
YEAR	YY	Year
HOUR	HH	Hour
MINUTE	MM	Minute
1,3,5.. ODD	1,3,5,29 1, 3, 5	Odd Days
2,4,6.. EVEN	2,4,6,30 2, 4, 6	Even Days
STATION		Station
START TIME		Start Time
RUN TIME		Run Time
REMAINING RUN TIME		Remaining Run Time
SEASONAL ADJUST %		Seasonal Adjust
DELAY		Rain Delay
MANUAL		Manual Watering
TEST		Test All Stations
DELAY	DELAY	Delay Between Valves

Normal Operation



Auto Run

Watering occurs automatically according to programmed irrigation schedules.

AUTO RUN is the normal operating mode. Return the dial to **AUTO RUN** when programming is complete.



1. Turn the dial to **AUTO RUN**.

In AUTO RUN Mode:

The display shows the day of the week and current time of the day.

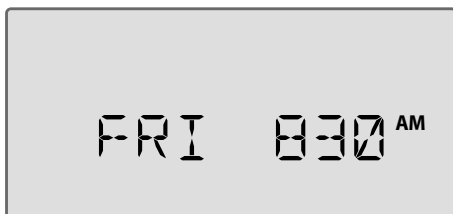

NOTE: There are cases where the display will not appear as it does on Figure 1. When Rain Delay is active or the Sensor Bypass is set to "Bypass" mode for 1 or more stations.

To Manually Start a Program:

2. Press the Program Select button to select a program.
3. Press and **HOLD** the **Hold to Manually Start** button to immediately run the displayed program.

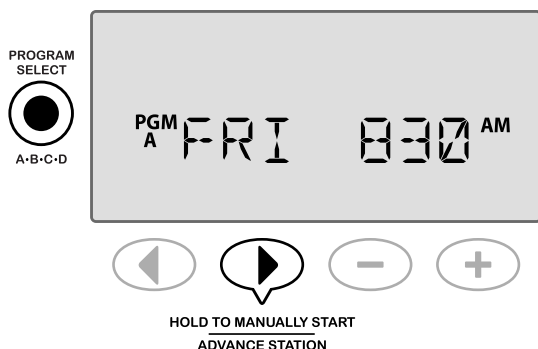

During Watering:

The display shows a blinking sprinkler symbol, the active Station number and the remaining Run Time for that station.

4. Press the **Advance Station** button to cancel watering for the active Station and advance to the next Station in the program.

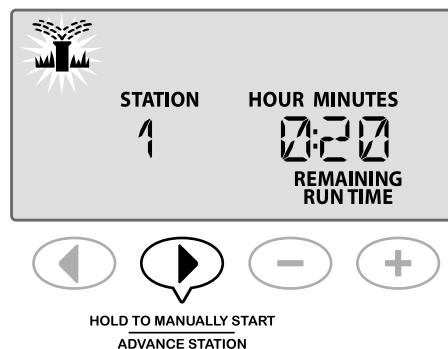

5. To cancel an active program, turn the controller dial to **OFF** and leave it there for at least 3 seconds and then turn the dial back to **AUTO RUN**.



Off

Cancel all active watering immediately and stop future automatic irrigation until the controller dial position returns to Auto Run.

SF SPECIAL FEATURE AVAILABLE

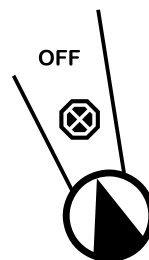

1. Turn the dial to **OFF**.



Programmed irrigation schedules and current date and time remain permanently stored in memory while the controller is **OFF** or if there is an unexpected loss of power.

NOTE: Automatic irrigation will NOT occur if the controller remains in **OFF** mode.

Basic Operation



Set Date

Set the current calendar Date.



1. Turn the dial to **Set Date**.
2. Press **-** or **+** to set the **DAY**, then press **▶**.
3. Press **-** or **+** to set the **MONTH**, then press **▶**.
4. Press **-** or **+** to set the **YEAR**.

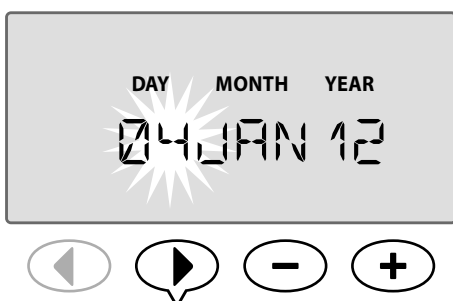

Set Time

Set the current Time of day.

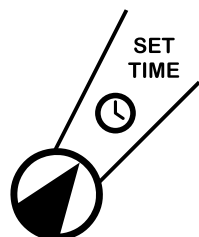

1. Turn the dial to **Set Time**.
2. Press **-** or **+** to set the **HOUR** (ensure that the **AM/PM** setting is correct), then press **▶**.
3. Press **-** or **+** to set the **MINUTES**.



! **NOTE:** The time will switch from AM to PM automatically. (Press and **HOLD -** or **+** to accelerate adjustments).

To change the time format (12 hour or 24 hour):

4. With **MINUTES** blinking, press **▶**.



5. Press **-** or **+** to select the desired time format, then press **▶** to return to the time setting.



! **NOTE:** The time format will default to your region based upon the electrical current that the controller detects. You can modify by following the steps above.



Program Select

Select a program to create or modify irrigation schedules.

1. Press the **Program Select** button to select the desired program, **A, B, C or D**.

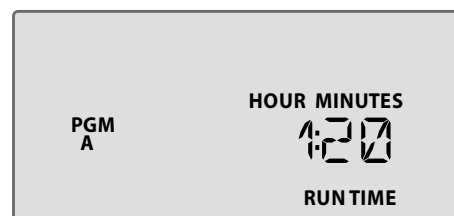

! **NOTE:** Make sure the desired program (A, B, C or D) is shown on the display during programming.



Set Watering Start Times

Set the time of day that a program begins to water.

Up to six Start Times (1–6) are available for each program.

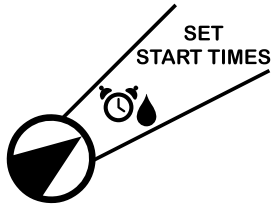

1. Turn the dial to **Set Watering Start Times.**
2. Press **−** or **+** to set the 1st Start Time (ensuring that the AM/PM setting is correct), then press **▶**.

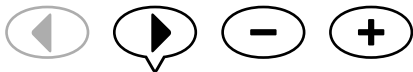
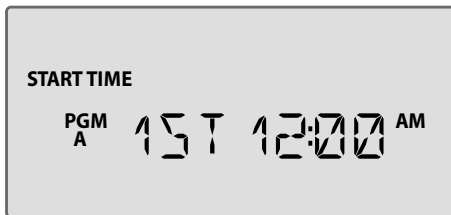

REPEAT as desired to set an additional Start Times (2nd, 3rd, etc.) for the selected program.

Each station in the selected program will run in sequence from 1 up to 22. Each program will run in sequence from A through D.

If you have the same start time included in more than 1 program, they will stack one upon the other. For example, if program A runs for 40 minutes and Program B is scheduled to run for 20 minutes, Program B will not start until program A has finished.

NOTE: Program A has a preset default start time of 8:00 AM. NO default start times are set for other programs.



Set Station Run Times

Set the duration of time that a station waters.

SF SPECIAL FEATURE AVAILABLE

Run Times can be set from one minute up to six hours. After 60 minutes the increments of adjustment will increase to 10 minute increments.

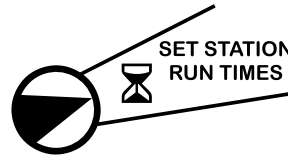

1. Turn the dial to **Set Station Run Times.**
2. Press **−** or **+** to set the desired Run Time for the selected Station, then press **▶**.

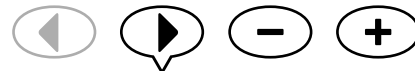
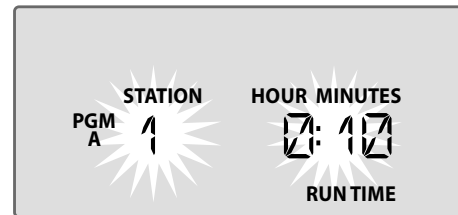

REPEAT to set the Run Time for each remaining Station in the selected program.

NOTE: Program A has default Run Times of 10 minutes for stations 1 through 4.



Select Days to Water

Introduction and Overview

A program can be scheduled to run on certain days of the week, specific dates on the calendar, or at regular intervals such as every third day.

There are four different watering options:

By Day (Custom/Default)

This is the default program option and also the most common. Set watering to occur on specific days of the week by choosing **ON** or **OFF** for that day of the week.

1, 3, 5...29 Odd Days

Set watering to occur on all ODD calendar days, for example 1, 3, 5...29

2, 4, 6...30 Even Days

Set watering to occur on all even calendar days, for example 2, 4, 6...30

Cyclic Days

Set watering to occur at specific intervals, for example, every 2 days, or every 3 days, etc.

Watering Options

Select the calendar days or intervals that a program is allowed to water.

By Day (Custom)

This is the default setting for the controller. Set watering to occur on specific days of the week by choosing **ON** or **OFF** for that day of the week.

To schedule By Day:

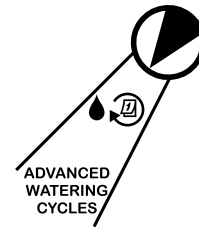

1. Turn the dial to **Advanced Watering Cycles**.

2. Press the **Program Select** button to select the desired program.

3. Press **-** or **+** to select **BY DAY**.

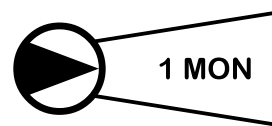
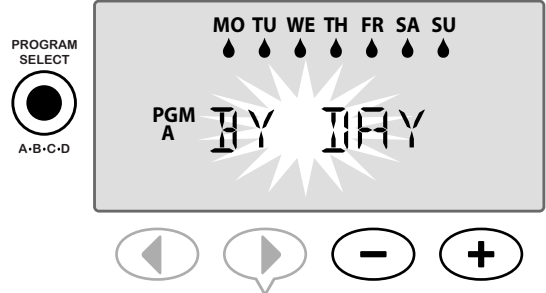

4. Turn the dial to **MON**.

5. Press **-** or **+** to set the selected day as either **OFF** or **ON** (default) for watering, then turn the dial to the next day of the week.

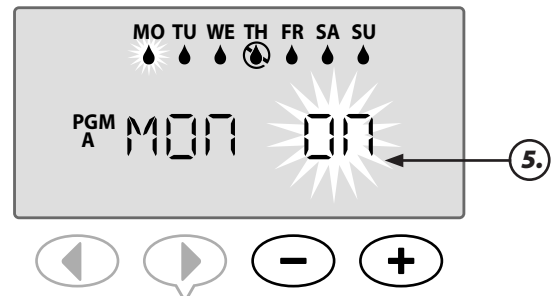

REPEAT to select additional days as desired for the selected program.

NOTE: In the example illustration, Thursday is shown as off and all other days are on.



Advanced Cycles

SF SPECIAL FEATURE AVAILABLE

If a user chooses not to set the watering schedule By Day, the user has 3 additional options.

Option One:

1, 3, 5...29 **Odd Days**

Set watering to occur on all ODD calendar days, for example 1, 3, 5...29

! **NOTE:** Watering doesn't occur when the last day of the month is an odd day, say February 29th or the 31st of any month.

To schedule Odd Days:



1. Turn the dial to **Advanced Watering Cycles**.
2. Press the **Program Select** button to select the desired program.
3. Press **-** or **+** to select **ODD**.

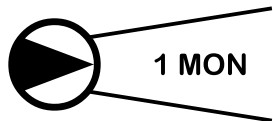
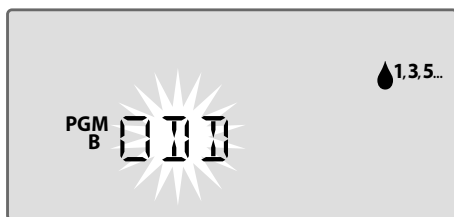

! **NOTE:** **ODD** is displayed when the dial is turned to any day of the week position.

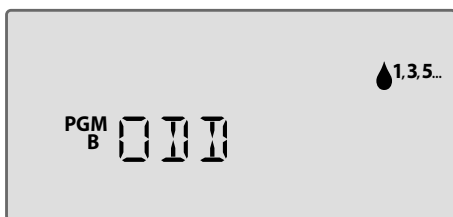

Option Two:

2, 4, 6...30 **Even Days**

Set watering to occur on all even calendar days, for example 2, 4, 6...30

To schedule Even Days:



1. Turn the dial to **Advanced Watering Cycles**.
2. Press the **Program Select** button to select the desired program.
3. Press **-** or **+** to select **EVEN**.

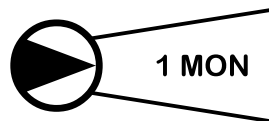

! **NOTE:** **EVEN** is displayed when the dial is turned to any day of the week position.



Option Three:

Cyclic Days

Set watering to occur at specific intervals, such as **every 2 days**, or **every 3 days**, etc.

To schedule Cyclic Days:

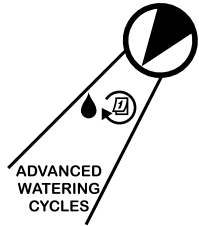

1. Turn the dial to **Advanced Watering Cycles**.
2. Press the **Program Select** button to select the desired program.
3. Press **-** or **+** to select **CYCLIC**, then press **▶**.

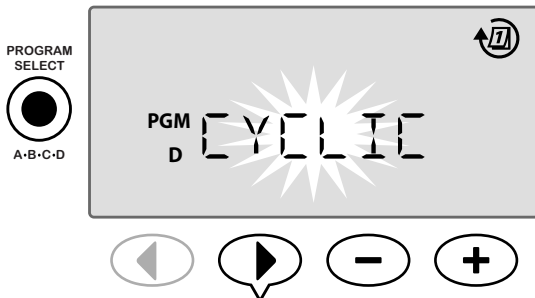

Day Cycle

The DAY CYCLE can be set from 2 to 31 days. For example, to water every other day, set the day cycle to "2". To water every 3rd day, set the day cycle to "3", etc.

4. Press **-** or **+** to set the desired DAY CYCLE (between 2-31 days), then press **▶**.

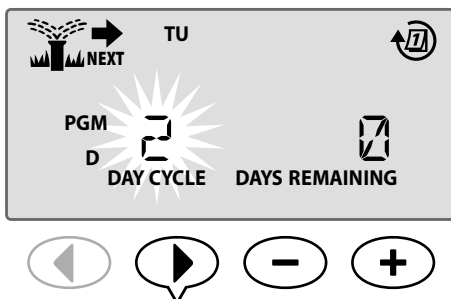

Days Remaining

The DAYS REMAINING can be set from 0 to 31 days. For example, if you want to begin watering tomorrow then set the DAYS REMAINING to "1".

5. Press **-** or **+** to set the DAYS REMAINING (between 0-31 days) before the next watering day. The NEXT watering day updates on the display to indicate when watering will start.

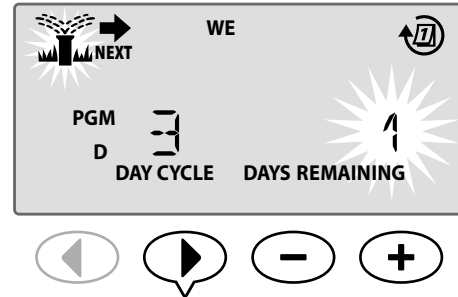

In the example, watering occurs every 3 days. Since days remaining is set to 1, watering begins on the next calendar day (shown in the example as Tuesday).

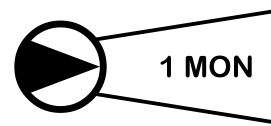

NOTE: **CYCLIC** is displayed when the dial is turned to any Select Days to Water position.



Advanced Options

For Basic Setup, see the Quick Reference Guide located inside the controller door.



Seasonal Adjust

Increase or decrease watering duration based on seasonal weather conditions.

SF SPECIAL FEATURE AVAILABLE

Run Times for all stations can be adjusted within a program by modifying seasonal adjust value.

The default setting will display all programs ABCD, the adjustment made will be applied to all programs. If you wish to apply a different adjustment % per program, press the program select button to choose your program and then increase or decrease the %.

! **NOTE:** The Seasonal Adjust value ranges from 5% to 200%. For example, a 150% adjustment means a Run Time of 10 minutes will become 15 minutes.

! **NOTE:** Seasonal Adjust will display all program icons on the display. To apply the seasonal adjust to all programs increase or decrease the percentage to the desired amount. If you only want to apply the adjustment to a specific program, press the program select button and choose the desired program and then make the adjustment.

Seasonal Adjust

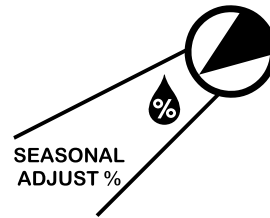

1. Turn the dial to **Seasonal Adjust %**.
2. Press **-** or **+** to increase or decrease the Seasonal Adjust percentage setting. (5 - 200%)

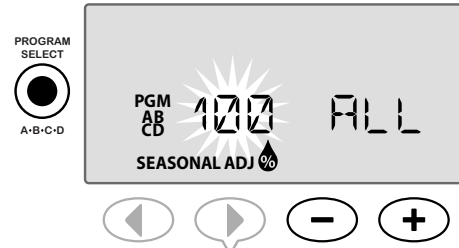

3. If adjustment will not be applied to all programs, press the **Program Select** button to select the desired program.

! **NOTE:** Displayed run times are inclusive of any seasonal adjustment made. Example: Station 1 has a run time set for 10 minutes. The program Seasonal Adjusted value is now set to 150%. The new actual run time is 10 minutes x 150% = 15 minutes.

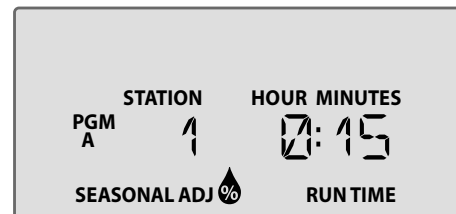

- !** **NOTE:** The Seasonal Adjust symbol will show on the display in **AUTO RUN**.
- !** **NOTE:** Running a Manual Station or Program will use the Seasonal Adjusted value.



Delay Watering

Delay watering if irrigation is not required due to rain, yard repairs, planned party, or any other reason you want to delay watering.

Automatic irrigation can be suspended for a period of up to 14 days even if no optional rain sensor is installed. After the delay expires, automatic irrigation resumes as scheduled.

NOTE: Delay Watering will not affect any station that is set to ignore a rain sensor (refer to Bypass Rain Sensor For Any Station in the Special Features section).

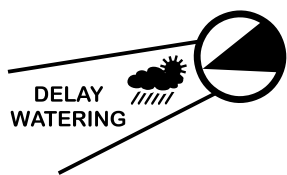

1. Turn the dial to **Delay Watering**.
2. Press **-** or **+** to set the DAYS REMAINING. The next watering days remaining will update on the display to indicate when watering will resume.

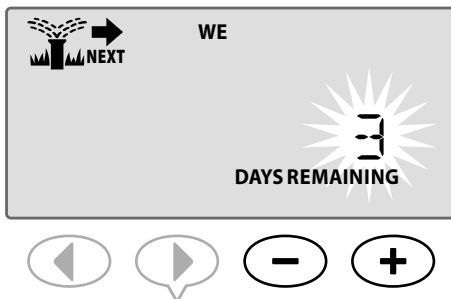

In the example above, irrigation will be delayed for 3 days. Normally scheduled watering will resume on Wednesday.

NOTE: Delay Watering settings will show on the display in **AUTO RUN**.



Rain Sensor

Set the controller to obey or ignore a rain sensor.

SF SPECIAL FEATURE AVAILABLE

If an optional rain sensor is installed, automatic irrigation will suspend if the sensor detects rainfall. When Rain Sensor is set to **BYPASS** all programs will ignore the rain sensor.

The sensor bypass setting applies to all programs and is not program specific. However, you can set any station to Bypass (Ignore) the sensor. Those stations set to ignore will not be affected by the rain sensor. This is common for areas that require watering regardless of rain fall. An example is plant material located under a covered area. For more details, see Bypass Rain Sensor For Any Station in the Special Features section.

NOTE: The ESP-Me Controller is not compatible with a Normally Open rain sensor. It is designed for use with a Normally Closed rain sensor.

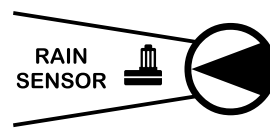

1. Turn the dial to **Rain Sensor**.
2. Press **-** or **+** to select **ACTIVE** or **BYPASS**.

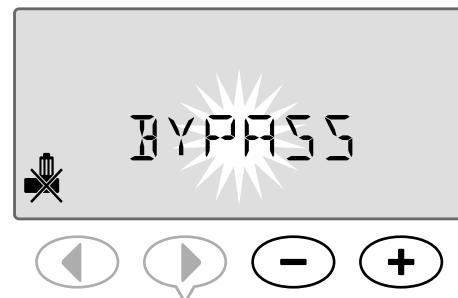

NOTE: The SENSOR BYPASS symbol will show on the display in **AUTO RUN** when **BYPASS** is selected.

Manual Watering Operations

Start watering immediately for any station or program.

! **NOTE:** All manual watering operations include the Seasonal Adjust value.

For manual watering, either by station or by program, two options exist to start watering:

1. After setting the desired watering time, press and **HOLD** the **Hold to Manually Start** button to begin watering immediately.

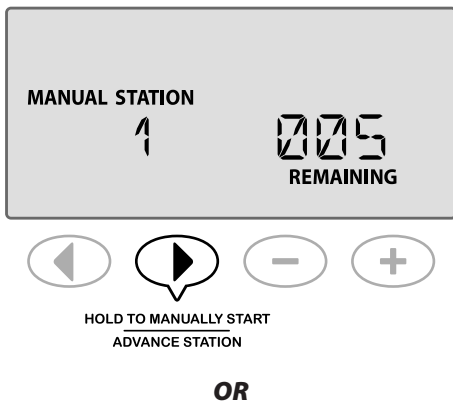

2. After setting the desired watering time, turn the dial to the **AUTO RUN** position to begin watering immediately.



Manual Station

Start watering immediately for any station.

Automatic irrigation events will be queued when manual watering is in progress.

! **NOTE:** All manual watering operations include the Seasonal Adjust value.

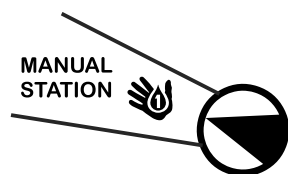

1. Turn the dial to **Manual Station**.

2. Press ◀ or ▶ to select the desired Station.

3. Press - or + to set the time REMAINING.

4. Press and **HOLD** the **Hold to Manually Start** button to begin watering, or you may return the dial position to the Auto Run position and irrigation will begin immediately.

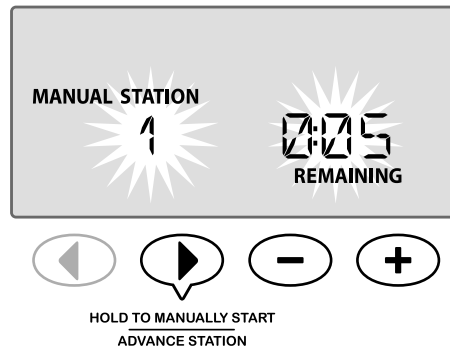

5. Irrigation will begin and "STARTED" will appear on the display.



During Manual Watering:

In **AUTO RUN** mode, the display shows a blinking sprinkler symbol, the active Station Number and the remaining Run Time.

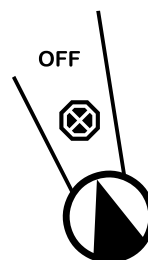
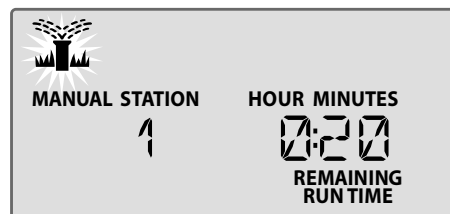

6. To cancel manual watering, turn the controller dial to **OFF** for three seconds and then back to **AUTO RUN**.



Manual Program

Start watering immediately for any program.

Automatic irrigation events for the same program will not run when manual program run is in progress.

! **NOTE:** All manual watering operations include the Seasonal Adjust value.

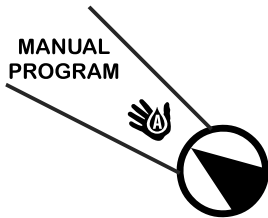

1. Turn the dial to **Manual Program.**

2. Press the **Program Select** button to select the desired program; the total run time for the program is displayed.

3. Press and **HOLD** the **Hold to Manually Start** button to begin watering.

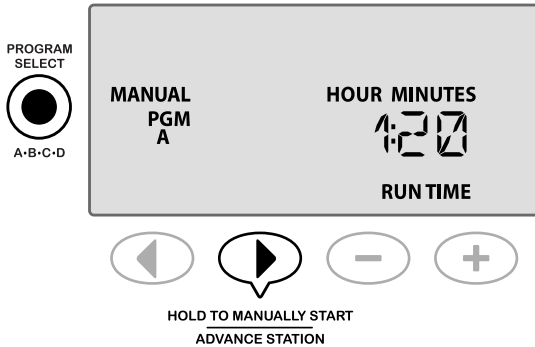

↻ REPEAT as desired to queue additional programs to run manually.

! **NOTE:** A maximum of 38 stations can be queued across all four programs.

4. Irrigation will begin and "STARTED" will appear on the display.



! **NOTE:** You can also run a manual program with the dial position set to Auto Run by pressing the **Program Select** button to select a program and then pressing the **Hold to Manually Start** button. Refer to Auto Run in the Normal Operation section for details.

During Manual Watering:

In **AUTO RUN** mode, the display shows a blinking sprinkler symbol, the active Station number and the remaining Run Time.

5. Press the **Advance Station** button to advance to the next station if desired.

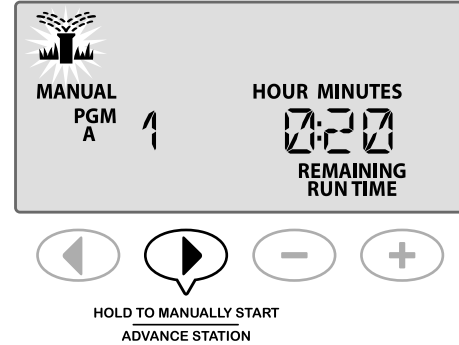

6. To cancel manual watering, turn the controller dial to **OFF** for three seconds and then back to **AUTO RUN**.



Total Run Time Calculator By Program

View the Total Run Time for an entire program.

The controller can determine the Total Run Time of a program by adding up all the Run Times for each station in that program.

To Determine Total Run Time By Program:

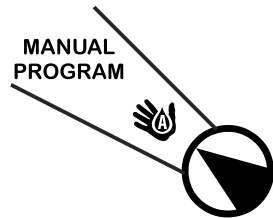

1. Turn the dial to **Manual Program**.
2. The Total Run Time for PGM A is displayed.

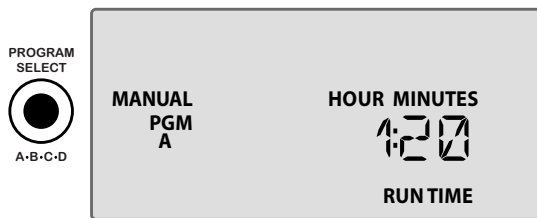

3. Press the **Program Select** button to view the Total Run Time for the next program.

REPEAT Step 3 to view Total Run Times for remaining programs.

NOTE: The run time displayed for each program is the seasonally adjusted run time and only includes one start time.

Test All Stations

Verify operation of valves in the system.

SF SPECIAL FEATURE AVAILABLE

Start a sequential test of every station that has a programmed Run Time.

NOTE: Any station that has a programmed Run Time of 0 minutes will not be tested.

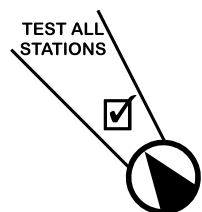

1. Turn the dial to **Test All Stations**.

2. Press **-** or **+** to set the desired Run Time.



3. Press and **HOLD** the **Hold to Manually Start** button to begin watering.
4. Turn the dial to **AUTO RUN** after the display shows TESTING.



HOLD TO MANUALLY START
ADVANCE STATION

During Testing:

In **AUTO RUN** mode, the display shows a blinking sprinkler symbol, the active Station number and the remaining Run Time.

5. Press the **Advance Station** button to advance to the next station if desired.



HOLD TO MANUALLY START
ADVANCE STATION

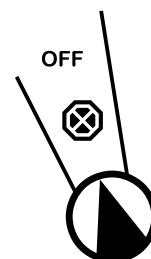

6. To cancel the test, turn the controller dial to **OFF** for three seconds and then back to **AUTO RUN**.

Special Features

Overview

The ESP-Me controller has some additional, or “Special Features” that offer enhanced irrigation control.

List of Special Features

Feature	Dial Position
• Delay Between Valves	OFF
• Set Master Valve By Station	Set Station Run Times
• Permanent Days Off	“Day” position (Mon, Tue, etc.)
• Bypass Rain Sensor For Any Station	Rain Sensor
• Reset to Factory Defaults	Seasonal Adjust
• Save Programs	Test All Stations
• Restore Saved Programs	Advanced Cycles

Dial positions that are used to access an additional Special Feature are indicated throughout this manual with a note as shown below:

SF SPECIAL FEATURE AVAILABLE

Special Features are accessed by pressing and HOLDING both ◀ and ▶ at the same time for at least 3 seconds, as shown in the illustration below.

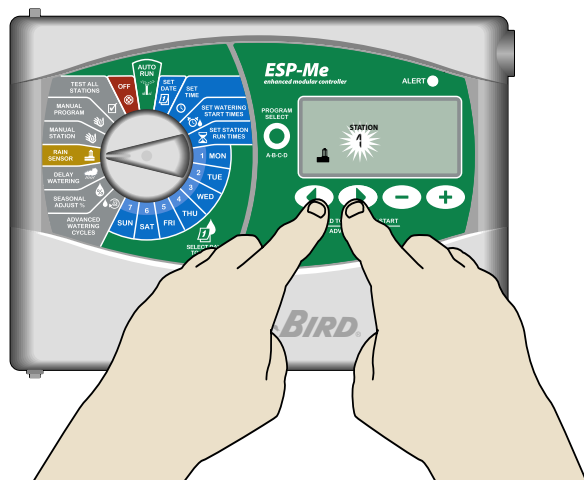

Delay Between Valves

Set a delay between stations for all programs.

SF SPECIAL FEATURE AVAILABLE

After a station has completed watering, the start of the next station can be delayed for a set period of time ranging from 2 seconds to 9 hours (the default value is 0 seconds). This ensures that a valve has completely closed before the next one opens.

NOTE: Some valves may take a long time to mechanically close. Opening a valve before another valve has completely closed could cause a loss in hydraulic pressure in the system. The Master Valve (MV) output obeys the inter-station delay as well.

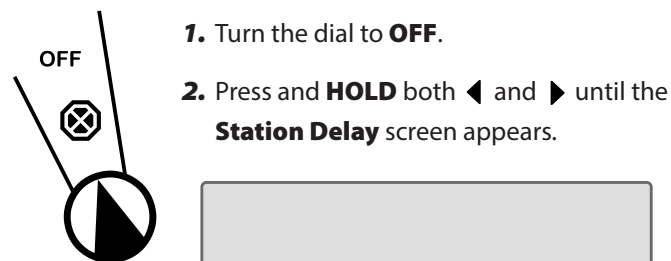

1. Turn the dial to **OFF**.
2. Press and **HOLD** both ◀ and ▶ until the **Station Delay** screen appears.



3. Press **−** or **+** to set the desired delay time.





4. In AUTO mode; when a delay between valve starts is in progress, the screen will alternate between showing "DELAY" and showing the amount of time remaining until the delay period between valve starts is complete.



5. When an Inter-Station Delay is in progress, press the **Advance Station** button to cancel and start watering for the station.

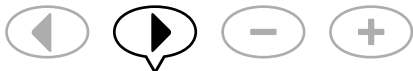

HOLD TO MANUALLY START
ADVANCE STATION

Set Master Valve By Station

Control the water supply to selected stations through the use of a master valve.

SPECIAL FEATURE AVAILABLE

In some systems, a master valve (or pump start relay) must be opened or activated to supply water to a valve. Set Master Valve Control to MV ON to allow a valve to be controlled by a master valve.

NOTE: The ESP-Me does not support a Normally Open Master Valve.

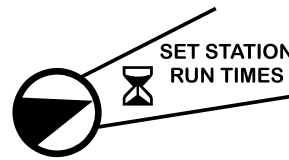

1. Turn the dial to **Set Station Run Times**.

2. Press and **HOLD** both ◀ and ▶ at the same time.

3. Press ◀ or ▶ to select the desired Station.

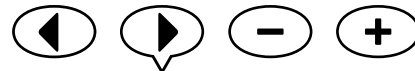
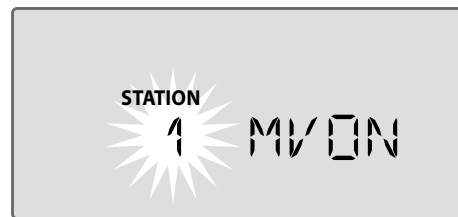

4. Press **-** or **+** to set **MV ON** or **MV OFF**.



NOTE: MV remains opened for assigned stations during Station Delay. For more details, see Station Delay in the previous section.

NOTE: MV status is defaulted to OFF for all stations.

Permanent Days Off

Prevent watering on selected days of the week.

SPECIAL FEATURE AVAILABLE

When the Odd Days, Even Days, or Cyclic Days option is selected under Advanced Cycles, a day of the week can be designated as a permanent non-watering day.



 **NOTE:** For example, you could schedule watering on all Odd Days with the exception of Thursdays if that is the day that your lawn is mowed.

 **NOTE:** Applies only to Odd, Even, or Cyclic programming.

 **1 MON**
1. Turn the dial to the desired day of the week (Select Days to Water).

2. Press and **HOLD** both ◀ and ▶ at the same time until the Permanent Days Off screen is displayed.

3. Press **—** or **+** to set any days as desired to be a Permanent Day Off.

 **NOTE:** When a day is selected as a Permanent Day Off, the  symbol is displayed to indicate no watering will occur on that day.

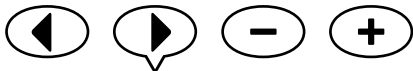

 **REPEAT** to set Permanent Day Off for other days as desired. Turn the dial to the desired day and use the **—** or **+** buttons to permanently turn the day off or back on.



Bypass Rain Sensor For Any Station

Set an individual station to obey or ignore a rain sensor.

SPECIAL FEATURE AVAILABLE

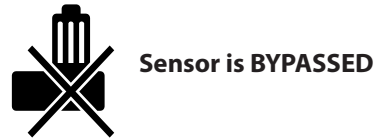
If an optional rain sensor is installed, automatic irrigation will suspend if the sensor detects rainfall. When Bypass Rain Sensor For Any Station is set to **BYPASS**, the selected station will ignore the rain sensor.

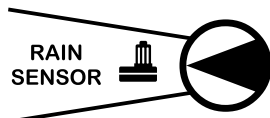

 **RAIN SENSOR** 
1. Turn the dial to **Rain Sensor**.
2. Press and **HOLD** both ◀ and ▶ at the same time until the **Bypass Rain Sensor For Any Station** screen appears.

3. Press ◀ or ▶ to select the desired Station.

4. Press **—** or **+** to select **ACTIVE** or **BYPASS**.

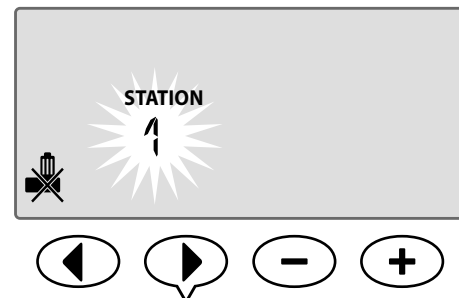

Additional Features

Additional Special Features are available, including:

- Reset to Factory Defaults
- Save and Restore Saved Programs

For more information see the Special Features Card, included with the ESP-Me Controller.

Installation

Installation Checklist

When installing the ESP-Me controller for the first time, it is recommended that you complete the following steps in order.

A check-off box is provided for each step:

- Check box contents (see page IV)
- Gather installation tools (see below)
- Select a location
- Mount the controller
- Connect controller power
- Install station modules (optional)
- Connect field wires
- Complete the installation

Gather Installation Tools

Before beginning installation, gather the following tools and materials:

- a. Marking pencil
- b. Phillips screwdriver (#1, #2, #3 tip)
- c. Flathead screwdriver
- d. Hammer
- e. Level
- f. Drill and drill bit (for #8 screws)
- g. Wire Stripper
- h. Mounting Screws (included)
- i. Wall Anchors (if needed)

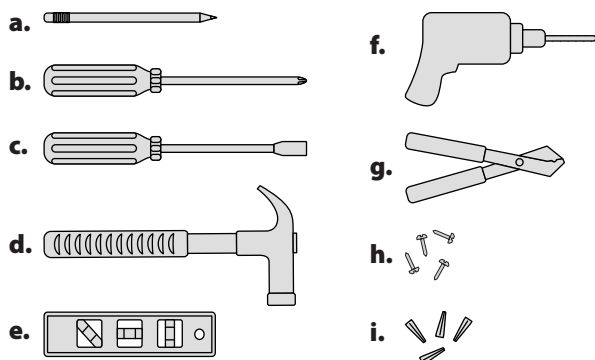

Mount Controller

Choose Location

1. Choose a suitable mounting location with access to an electrical power source. Allow clearance for conduit connections below the unit, and for the hinged door (outdoor model only) to swing fully open to the left.

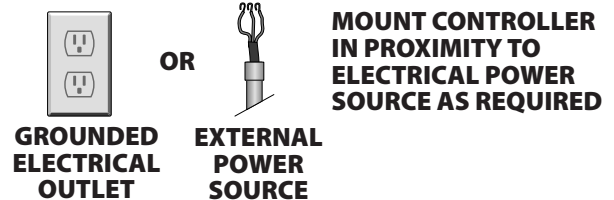
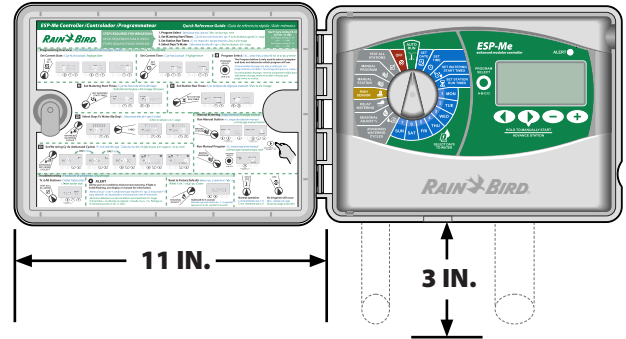

NOTE: The operating temperature range is 14°F to +149°F (-10°C to +65°C).

Remove Front Panel

1. Open the door of the controller and swing it to the left. If desired, remove it from the hinges by first pressing upward and then pulling outward at the bottom.
2. Pull open the front panel, swing it to the left and disconnect the ribbon cable by gently pulling the connector out of the socket.

CAUTION: Be careful not to bend the pins in the sockets when detaching the ribbon cable.

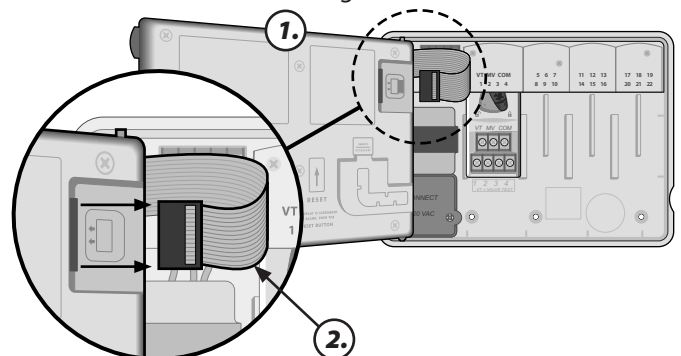

NOTE: Outdoor model shown with internal transformer *

- Remove the front panel by gently pulling the panel upward and sliding the bottom corner pin out of the lower pin-hole.

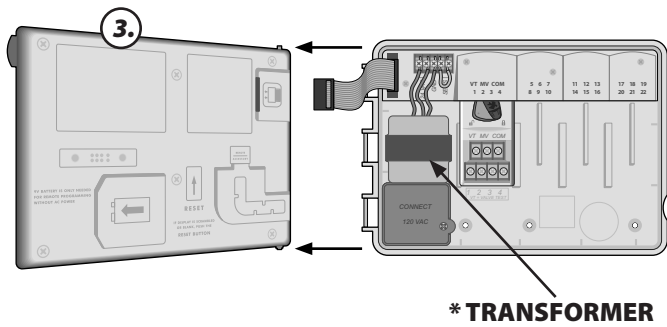

Remove Knock-outs

The ESP-Me controller cabinet has four “knock-outs” available for connecting conduit and routing field wires.

Three knock-outs are located on the underside of the cabinet and one is located on the back.

Tools Required:

- Flat-head screwdriver
- Hammer

If a knockout needs to be removed:

- Place the blade of the screwdriver into the groove around the knockout and tap it with a hammer.
- Punch a hole through the material in two or more places and twist to remove.

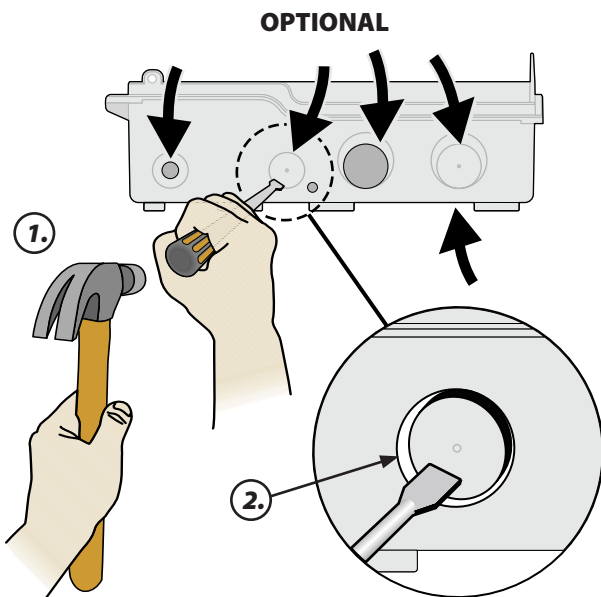

Mount Controller

- Drive a mounting screw for the top anchor into the wall. Leave an 1/8 inch gap between the screw head and the wall surface. (Use wall anchors if necessary.)
- Locate the keyhole slot on back of the controller unit and hang the unit securely on the mounting screw.

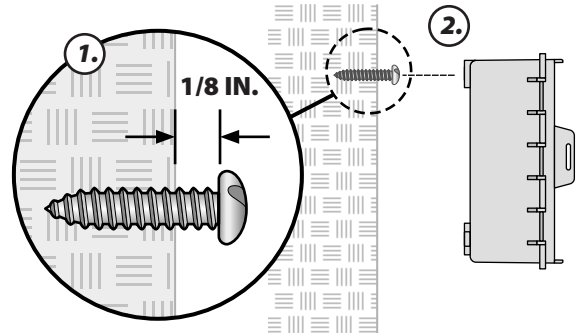

- Ensure the unit is level.
- Drive three additional mounting screws through the open holes inside the controller and into the wall. Verify that the unit is fastened securely to the wall.

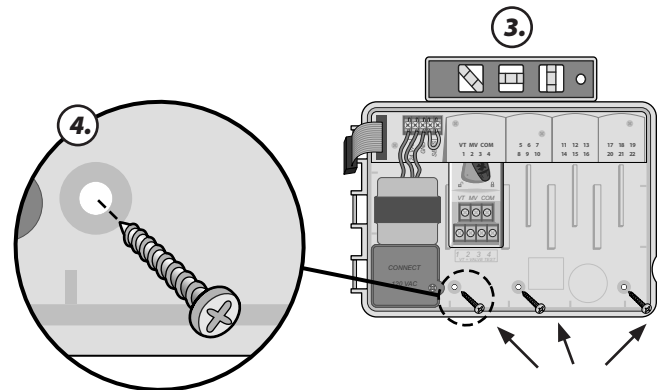

Connect Power

⚠ WARNING: DO NOT plug in the transformer or connect external power until you have completed and checked all wiring connections.

⚠ WARNING: All electrical connections and wiring runs must comply with local building codes. Some building codes require that only a licensed or certified electrician can make the power connections. Please check with your local building code for guidance. Only professional personnel shall install the controller.

Electrical Specifications (230V only)	
Input	230VAC, 0.2AMP, 50/60Hz
Output	25.5VAC, 1.0AMP, 50/60Hz

Indoor Model

1. Route the transformer power cord through the conduit opening at the bottom left of the unit. Knot the cable/cord inside the controller cabinet to prevent it from being pulled out.

⚠ CAUTION: Do not route the power cord through the field wire opening at the bottom right of the unit.

2. Connect the two power wires on the cord to the two 24VAC terminal connections on the controller.

3. Connect the ground wire on the cord to the GND terminal.

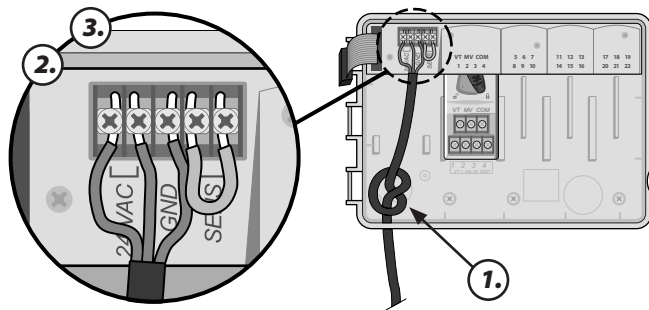

4. Plug the transformer into an electrical outlet.

Outdoor Model

The ESP-Me outdoor controller has an internal transformer that reduces supply voltage (120 VAC in U.S. models; 230 VAC in international models; 240 VAC in Australian models) to 24 VAC. You will need to connect power supply wires to the transformer's three wires. (Line, Neutral, Ground).

⚠ WARNING: Electric shock can cause severe injury or death. Make sure power supply is turned OFF before connecting power wires.

Power Wiring Connections	
120VAC (USA)	230VAC (International)
Black supply wire (hot) to the black transformer wire	Black supply wire (hot) to the black transformer wire labeled with "L"
White supply wire (neutral) to the white transformer wire	Blue supply wire (neutral) to the blue transformer wire labeled with "N"
Green supply wire (ground) to the green transformer wire	Green-with-yellow-stripe supply wire (ground) to the green-with-yellow-stripe transformer wire ($\frac{1}{2}$)

1. Locate the transformer wiring compartment in the lower left corner of the controller unit. Use a screwdriver to remove the cover and expose the transformer connection wires.

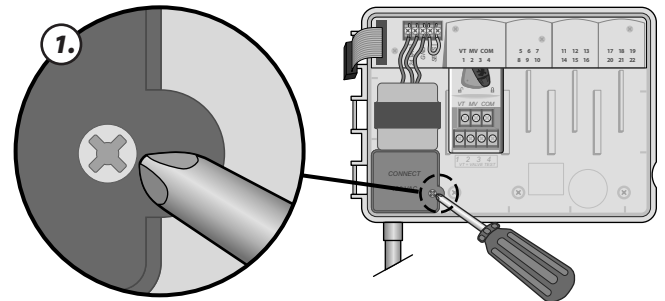

2. Route the three external power source wires through the conduit opening at the bottom of the unit and into the wiring compartment.

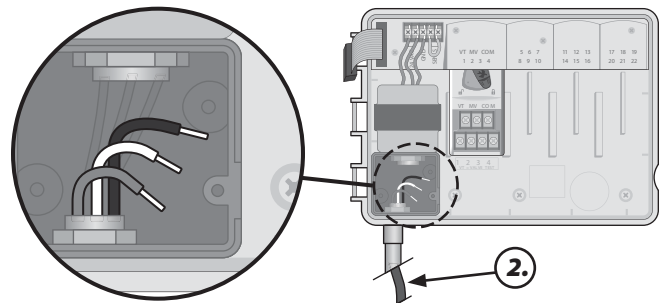

- 3. For 120V:** Using the provided wire nuts, connect the external power source wires (two power and one ground) to the transformer connection wires inside the wiring compartment.

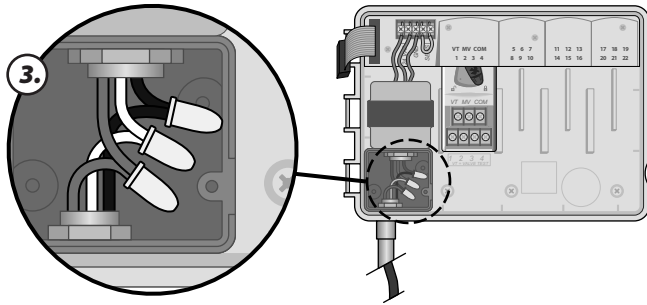

- For 230V:** Use either the provided wire nuts or the installed connector for this step.

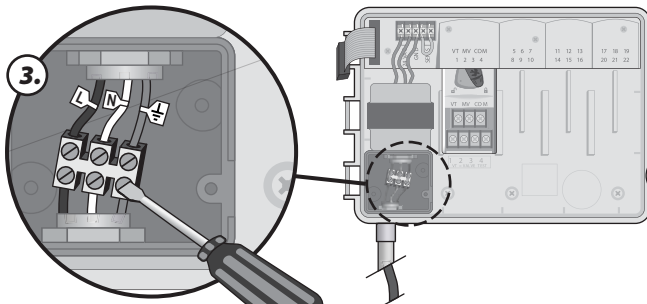

⚠ WARNING: Ground wire must be connected to provide electrical surge protection. Permanently mounted conduit shall be used for connecting main voltage to the controller.

- 4.** Verify that all wiring connections are secure, then replace the wiring compartment cover and secure it with the screw.

Station Expansion Modules

Optional Station Modules are installed in the empty slots to the right of the base module. Installation of 6-Station or 3-Station Modules into those slots can increase the station capacity up to 22 stations.

Module Options

**Base Module
(included)**



**Expansion Modules
(sold separately)**



**3-STATION
(ESPMe3)**



**6-STATION
(ESPMe6)**

- ⚠ NOTE:** 6-Station module is compatible only with the ESP-Me. They are not backwards compatible with the previous vintage controller.
- ⚠ NOTE:** For ideal station sequencing, it is recommended that a 6-Station module always be installed in the Bay 2. For more details see Station Numbering section.

Install Modules

- 1.** Verify the securing lever on the module is in the unlocked position (slide to the left).
- 2.** Place the module under the desired slot between the plastic rails.

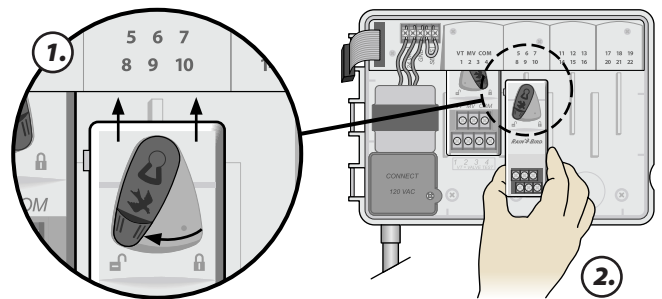

- 3.** Push the module up into the slot until secure.

4. Slide the securing lever to the locked position (slide to the right).

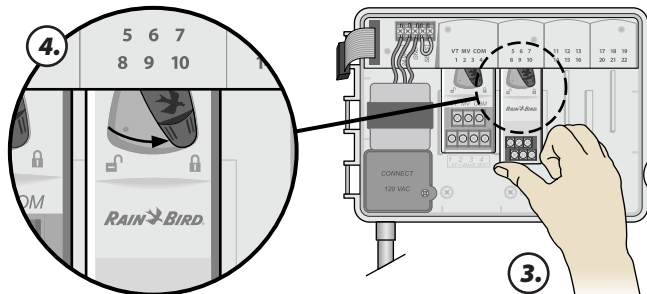

REPEAT for additional modules.

NOTE: Modules can be installed or removed with OR without AC power connected. They are considered “hot-swappable”.

Station Numbering

Fixed Station Numbering Description

The controller is configured with Fixed Station Numbering. Each bay is set up to accept a 6 station module and reserve the station number for future use if a 6 station module is NOT installed in Bays 2, 3 or 4.

Station numbers are pre-assigned as follows:

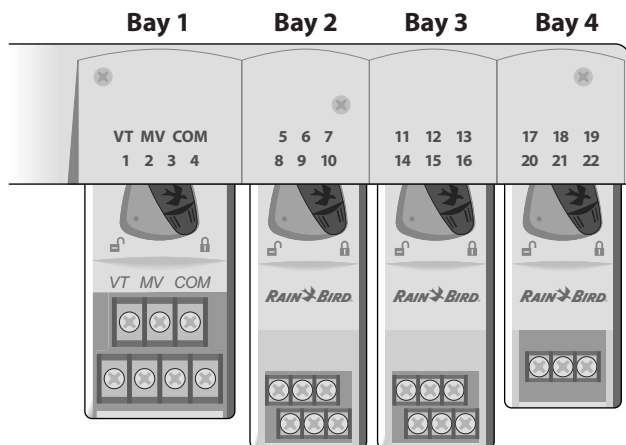

Example Of Optimum Installation Of 19 Stations

Module Configuration

Why Proper Configuration Is So Important

Example of installation with station numbering gaps:

- A total of 19 stations are installed.
- The Base Module is installed in Bay 1 and uses Stations 1 through 4.
- A 6-Station Expansion Module is installed in Bays 2 and 3.
- A 3-Station module is installed in Bay 4 and uses stations numbered 17 through 19.

Because a 3-Station module is installed in Bay 4, only the first three station numbers assigned to that bay will be used and the unused numbers will be “reserved” for future use.

During programming, the controller will skip any unused station numbers, creating a gap in station numbering.

In our example a 3-Station module was installed in Bay 4, so stations 20-22 will be unavailable for programming. During programming the missing stations will show on the display as 20NOMOD, 21NOMOD, etc.



The screen displays “20NOMOD” with the “20” flashing to indicate that Station 20 (and also 21-22) are unused and unavailable for programming.

NOTE: Station numbering gaps will not prevent the controller from operating properly. It only affects station numbering. During programming when connected to AC power, the controller will skip any unused stations where a module is not installed.

Wiring Connections

Connect the valve wires for each station and for a (optional) Master Valve, Pump Start Relay or Rain Sensor.

Connect Valves

1. Route the valve wires through a knock-out opening at the bottom or back of the unit.

CAUTION: Do not route the valve wires through the same opening as the power wiring.

2. Connect the power wire from each valve to the terminal on the base module or Station Module that corresponds to the desired station number (1-22).

3. Connect the common wire from each valve to the COMMON (COM) terminal on the base module.

4. To perform a Valve Test- connect the common wire to the "COM" terminal and the power wire to the "VT" terminal. This will immediately turn the valve "ON".

WARNING: The "VT" terminal is always powered "ON".

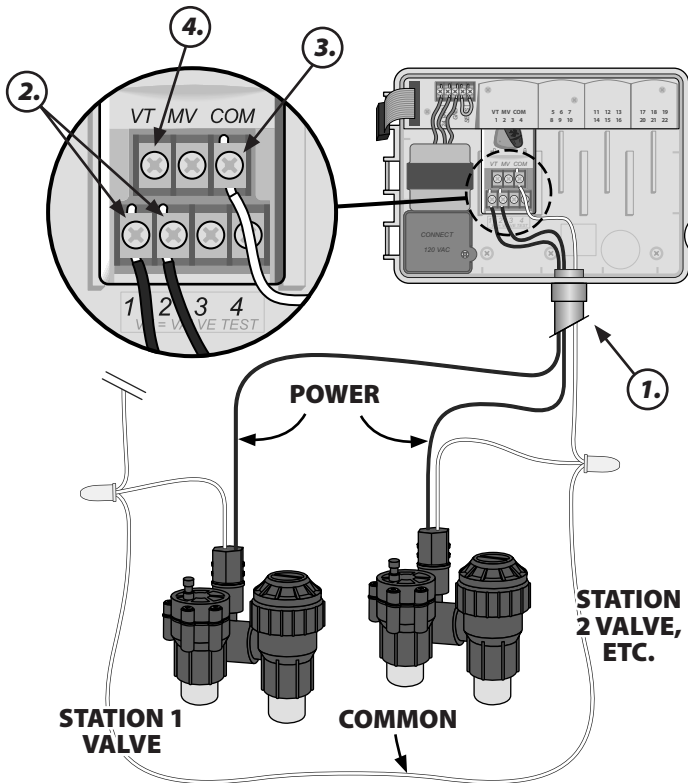

Connect Master Valve

Connect an optional Master Valve to the ESP-Me controller.

1. Route the master valve wires through a knock-out opening at the bottom or back of the unit.

CAUTION: Do not route the master valve wires through the same opening as the power wiring.

2. Connect the power wire from the master valve to the master (MV) terminal on the base module.

3. Connect the common wire from the master valve to the COMMON (COM) terminal on the base module.

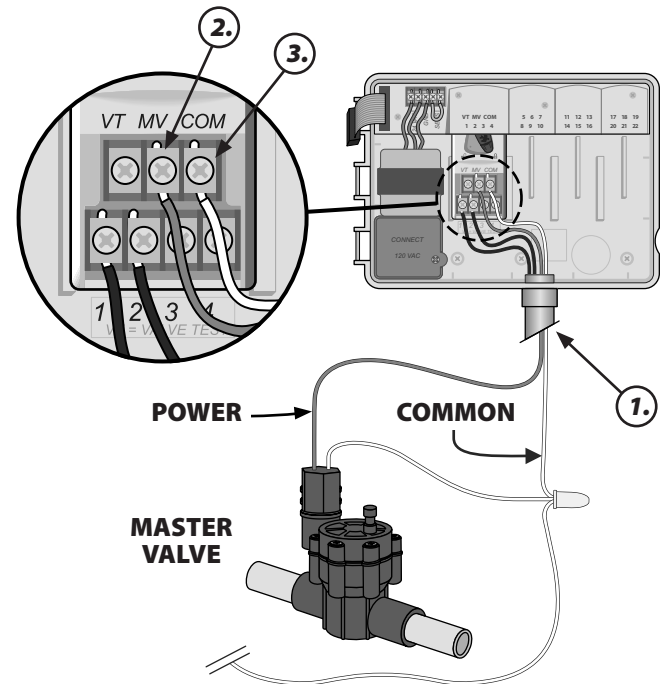

Connect Pump Start Relay

Connect an optional Pump Start Relay to the ESP-Me controller.

Pumps are used in some places to draw water from a well or other source. If you are activating a pump from the controller, you must install a Pump Start Relay.

A Pump Start Relay connects to the controller in the same way as a Master Valve, but connects differently at the water source.

NOTE: The ESP-Me controller DOES NOT provide main power for a pump.

1. Route the pump start relay wires through a knock-out opening at the bottom or back of the unit.

CAUTION: Do not route the pump start relay wires through the same opening as the power wiring.

2. Connect the Relay Input wire from the Pump Start Relay to the master (MV) terminal on the base module.

3. Connect the common wire from the Pump Start Relay to the COMMON (COM) terminal on the base module.

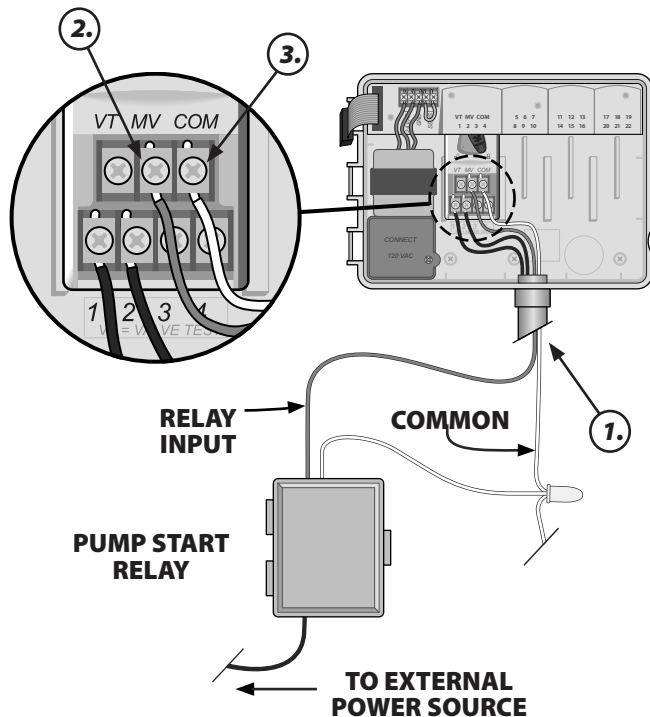

4. Connect a short jumper wire from any unused station terminal to a terminal in use.

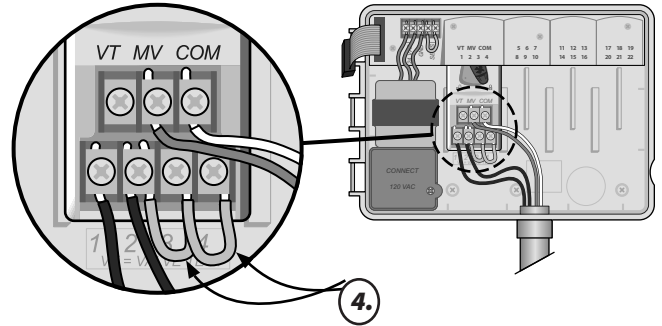

CAUTION: To avoid Dead Heading your pump do one of the following for all unused stations (module installed but not connected to a station wire):

- Connect jumper wire across unused stations.
- Set Station Run Time(s) to 0.
- Set the station to Bypass the MV. (Refer to Set Master Valve By Station in the Special Features section.)

NOTE: Default run times for program A is 10 minutes for stations 1-4.

NOTE: The controller can support a maximum Coil Inrush current of 11VA and a maximum Coil Hold current of 5VA.

The following Rain Bird Pump Start Relays are available in the USA only:

- RBSR24WG1 - Universal Pump Start Relay
- RBPL24WG1 - Pump Start Relay with Pressure Switch

For the most up to date compatibility list of pump start relays, visit our website at:

www.rainbird.com/controllersupport

NOTE: This controller is not compatible with the Hunter® PSR22 and PSR52.

Connect Optional Rain Sensor (Wired or Wireless)

Connect an optional rain sensor to the ESP-Me controller.

NOTE: The ESP-Me Controller is not compatible with a Normally Open rain sensor. It is designed for use with a Normally Closed rain sensor.

1. On the terminal strip, remove the yellow jumper wire from the SENS terminals and discard.

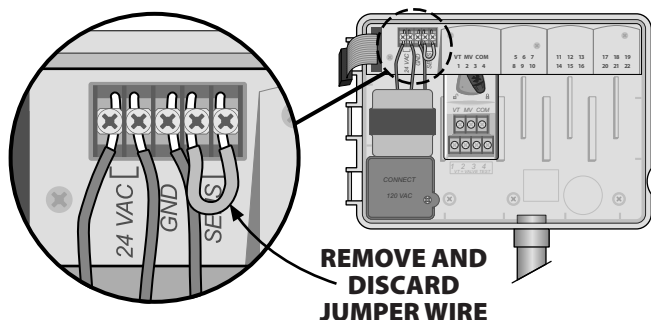

2. Route the rain sensor wires through a knock-out opening at the bottom or back of the unit.

CAUTION: Do not route the rain sensor wires through the same opening as the power wiring.

3. Connect both Rain Sensor wires to the SENS terminals.

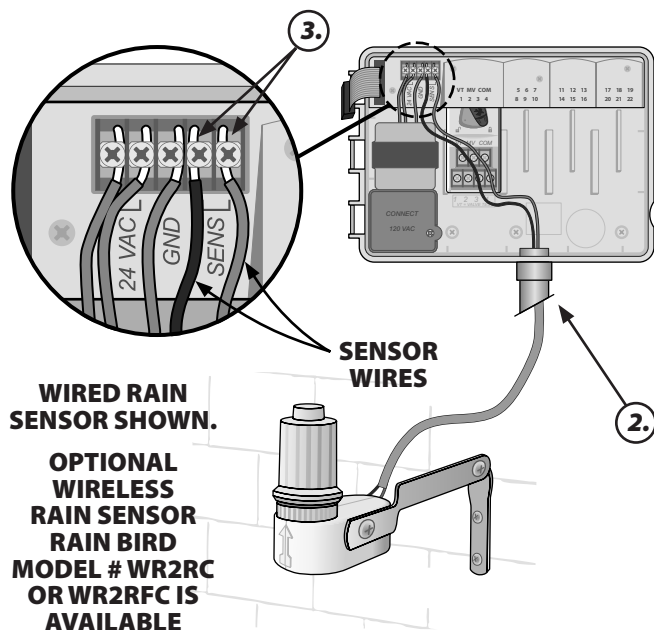

Set Rain Sensor to Active (after installing a rain sensor and removing jumper wire on backplane)

Set the controller to obey a rain sensor.

With a rain sensor is installed, automatic irrigation will suspend if the sensor detects rainfall. When Sensor Bypass is set to **ACTIVE** all programs will obey the rain sensor.

1. Turn the dial to **Rain Sensor**.
2. Press **-** or **+** to select **ACTIVE**.

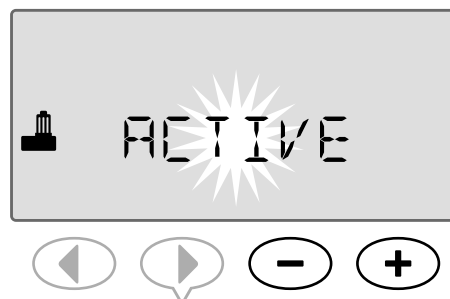

The rain sensor symbol will show on the display in **AUTO RUN** or **OFF** when Rain Sensor is set to **BYPASS**.



When Rain Sensor is set to **ACTIVE**, no symbol is shown.



NOTE: For more details see the Rain Sensor section in the Advanced Options section of this manual.

NOTE: The Alert light no longer illuminates when irrigation is delayed due to rainfall.

Complete Installation

1. Reinstall the front panel by first inserting the top corner pin into the top pin-hole.
2. Then gently pull upward and slide the bottom corner pin into the lower pin-hole.

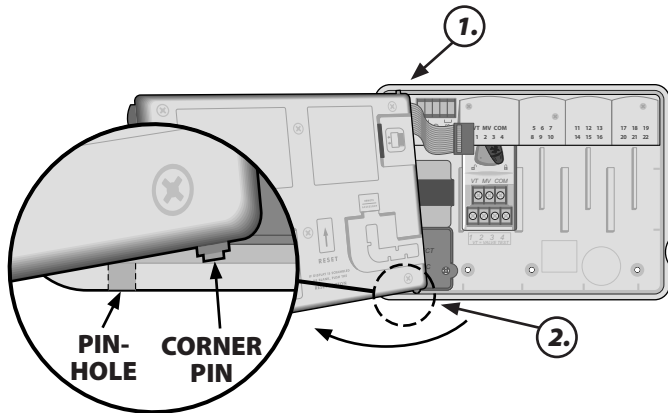

3. Reconnect the ribbon cable to the front panel by gently pushing the connector into the socket (Red line on ribbon cable towards the top).

 **CAUTION:** Be careful NOT to bend the socket pins.

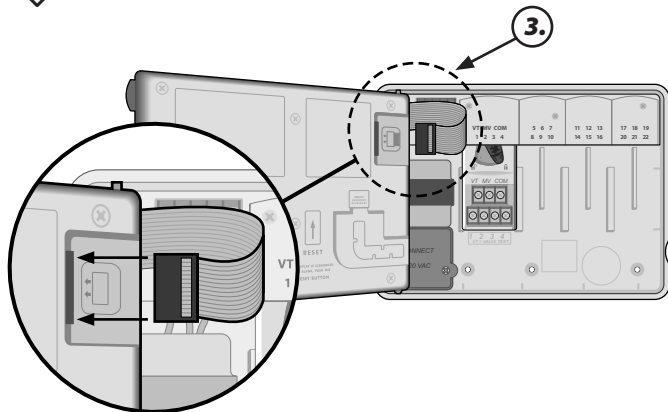

4. Reinstall the outer door if necessary.
5. Apply power to the controller and test the system.

 **NOTE:** The electrical connections can be checked even if water is not available. If water is available and you would like to test some or all of your stations, use the Test All Stations feature of the controller.

Optional Features

Connect Optional Accessory

- !** **NOTE:** Use only Rain Bird approved devices with 5 pin accessory port. Unapproved devices may damage controller and void warranty.

1. The front panel provides a port for the use of external devices, such as the Rain Bird LIMR Remote.

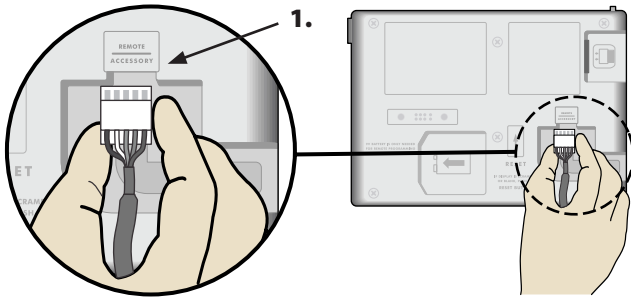

Remote Programming

Program the front panel remotely on battery power.

The front panel can be removed from the controller and programmed remotely using a 9 volt battery for power. Settings can be programmed for all 22 stations regardless of which station modules are installed in the controller.

- !** **NOTE:** This is useful if a contractor wants to program the controller prior to installation on site.

1. Remove the front panel (refer to Remove Front Panel in the Installation section).
2. Install a 9V battery in the battery compartment.

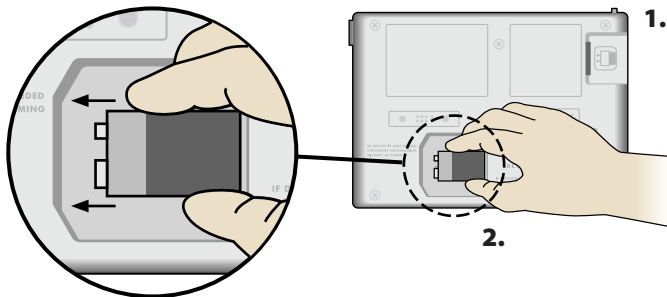

3. Program the controller.

- !** **NOTE:** Program information is stored in nonvolatile memory so it is never lost if the front panel loses power.

4. Replace the front panel (refer to Complete Installation in the Installation section).

- !** **NOTE:** After the front panel is re-installed, any station that does not have a corresponding Station Module installed will function as though the run time is zero.

Troubleshooting

Battery Life

If the display repeatedly shows “-----” when using a 9V battery for remote programming, replace the battery.

Reset Button

Press RESET if the controller is not working properly.

The Reset button resets the controller. Active irrigation is canceled, but all previously programmed watering schedules remain stored in memory. Irrigation will resume at the next scheduled Start Time.

1. Insert a small tool into the access hole and press until the controller is reset.

NOTE: We suggest using a non-metallic object such as a pencil or pen to press the Reset button.

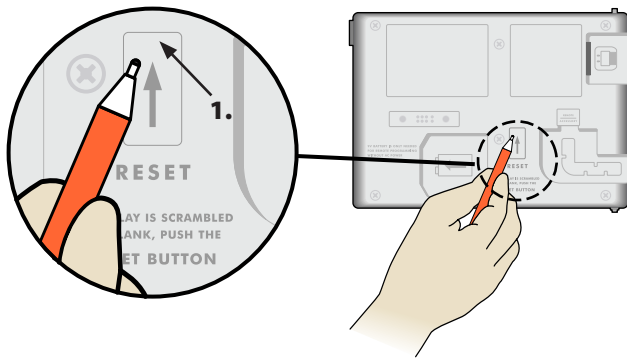

Error Detection

The ESP-Me controller has built-in error detection that can automatically generate an alert caused by an essential programming error or if an electrical short condition is detected.

The Alert LED light on the ESP-Me controller front panel will light up to indicate an alarm condition:



Programming Errors (blinking LED)

Error	Alert LED	Error Message On Display
No Start Times are set	BLINK	NO START TIMES
No Run Times are set	BLINK	NO RUN TIMES
No Watering Days are set	BLINK	NO WATER DAYS

The ESP-Me controller will reset or clear when the error is corrected.

NOTE: The dial must be in the AUTO RUN position for an Alert message to appear on the display.

Electrical Errors (non-blinking LED)

Error	Alert LED	Error Message On Display
Master Valve short	SOLID	MASTER VALVE/PUMP WIRE SHORTED OR HIGH CURRENT
Station short	SOLID	STATION “X” WIRE SHORTED

When an electrical error is detected, irrigation for the affected station is cancelled and watering advances to the next operable station in the program.

The controller will attempt to water the affected station again at the next scheduled watering. Completion of a successful watering will clear the error condition associated with that station.



Clearing Electrical Error Alerts

Turn the dial to the AUTO RUN position to view the error message on the display. To clear the Alert, press the right arrow key

Frequently Asked Questions

Problem	Possible Cause	Possible Solution
Display shows a program is active, but system isn't watering.	Water source not supplying water.	Verify there is no disruption to the main water line and that all other water supply lines are open and functioning properly.
	Wiring is loose or not properly connected.	Check that field wiring and master valve or pump start relay wiring is securely connected at the controller and in the field.
	Field wires are corroded or damaged.	Check field wiring for damage and replace if necessary. Check wiring connections and replace with watertight splice connectors if needed.
	Loss of AC power.	When there is a power loss and a 9 volt battery is installed, the system does not irrigate but programs show as remaining active.
NO AC message on display.	No Power detected.	Check circuit breaker and that unit is plugged into socket or properly connected to power source.
	Controller may be plugged into a GFI outlet or an outlet that is wired to a GFI outlet.	Check power to the outlet or reset the circuit breaker.
Programmed schedules do not start.	Connected rain sensor may be activated.	Set Rain Sensor to BYPASS to ignore the rain sensor. If watering resumes, the sensor is operating properly and no further correction is needed.
	Connected rain sensor may not be operating properly.	Let the rain sensor dry out, or disconnect it from the controller terminal strip and replace it with a jumper wire connecting the two SENS terminals, or set to Bypass.
	If no rain sensor is connected, the jumper wire connecting the two SENS terminals on the terminal strip may be missing or damaged.	Move dial position to Sensor Bypass and set to Bypass.
It just rained and the alarm light is not illuminated, why?	This is normal operation. The ESP-Me does not consider the interruption of irrigation due to rainfall an alarm condition.	This is normal operation.

Electrical Issues (solid LED illuminated)

Problem	Possible Cause	Possible Solution
Display is blank, frozen or will not accept programming.	Power not reaching the controller.	Verify the main AC power supply is securely plugged in or connected and working properly.
	Controller needs to be reset.	Press the Reset Button. For details see "Reset Button" section.
	An electrical surge may have interfered with the controller's electronics.	Unplug the controller for 2 minutes, then plug it back in. If there is no permanent damage, the controller should accept programming and resume normal operation.
Automatic error detection indicates a problem by Alert LED and an error message on display.	Short circuit or overload condition in valve, master valve or pump start relay wiring.	Identify and repair the fault in the wiring. Refer to compatible pump start relays. For details see "Connect Pump Start Relay" section.
LED is flashing or solidly illuminated but I see no message on the LCD.	Dial not in AUTO RUN position.	Turn dial to AUTO RUN position.

for more details visit www.rainbird.com/controllersupport



Declaration of Conformity

Rain Bird Corporation hereby declares that the ESP-Me irrigation controller families conform to the European Directives 2004/108/EC for "Electromagnetic Compatibility" and 2006/95/EC for "Low Voltage"

Place San Diego

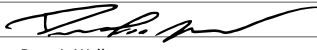
Signature 

Full Name Ryan L. Walker

Position Director

Rain Bird Corporation
 970 W. Sierra Madre
 Azusa, California 91702
 U.S.A
 626-963-9311

Rain Bird International, Inc.
 145 North Grand Avenue
 Glendora, CA 91741
 U.S.A
 626-963-9311

Rain Bird Europe
 900 rue-Ampere, BP 72000
 13792 Aix-en-Provence
 CEDEX 3 FRANCE
 (33) 04 42 24 44 61

**Technical Services for U.S.
 and Canada only:**
 1 (800) RAINBIRD

www.rainbird.com

FCC Part 15

This equipment has been tested and found to comply with the limits for a Class B digital device, pursuant to Part 15 of the FCC Rules. These limits are designed to provide reasonable protection against harmful interference in a residential installation. This equipment generates, uses, and can radiate radio frequency energy and, if not installed and used in accordance with the instructions, may cause harmful interference to radio communications. However, there is no guarantee that interference will not occur in a particular installation. If the equipment does cause harmful interference to radio or television reception, which can be determined by turning the equipment off and on, the user is encouraged to try to correct the interference by the following measures:

- Reorient or relocate the receiving antenna.
- Increase the separation between the equipment and receiver.
- Connect the equipment into an outlet on a circuit different from that to which the receiver is connected.
- Consult the dealer or an experienced radio/TV technician for help.

Changes or modifications not expressly approved by Rain Bird Corporation could void the user's authority to operate the equipment. This product was FCC certified under test conditions that included the use of shielded I/O cables and connectors between system components. To be in compliance with FCC regulations, the user must use shielded cables and connectors and install them properly.



Rain Bird Corporation
 6991 East Southpoint Road
 Tucson, AZ 85756
 USA
 Tel: (520) 741-6100
 Fax: (520) 741-6522

Rain Bird International
 1000 West Sierra Madre Avenue
 Azusa, CA 91702
 USA
 Tel: +1 (626) 963-9311
 Fax: +1 (626) 852-7343

Rain Bird Europe SNC
 900, rue Ampère, B.P. 72000
 13792 Aix en Provence Cedex 3
 FRANCE
 Tel: (33) 4 42 24 44 61
 Fax: (33) 4 42 24 24 72

Rain Bird France SNC
 900, rue Ampère, B.P. 72000
 13792 Aix en Provence Cedex 3
 FRANCE
 Tel: (33) 4 42 24 44 61
 Fax: (33) 4 42 24 24 72

Rain Bird Ibérica. S.A.
 Polígono Ind. Pinares Llanos
 C/ Carpinteros, 12, 2ºC
 28670 Villaviciosa de Odón, Madrid
 ESPAÑA
 Tel: (34) 91 632 48 10
 Fax: (34) 91 632 46 45

Rain Bird Desutschland GmbH
 Oberjesinger Str. 53
 71083 Herrenberg-Kuppigen
 DEUTSCHLAND
 Tel: (49) 07032 99010
 Fax: (49) 07032 9901 11

Rain Bird Sverige AB
 Fleningevägen 315
 254 77 Fleninge
 SWEDEN
 Tel: (46) 42 25 04 80
 Fax : (46) 42 20 40 65

Rain Bird Turkey
 İstiklal Mahallesi,
 Alemdağ Caddesi, No.262
 34760 Ümraniye İstanbul
 TÜRKİYE
 Tel: (90) 216 443 75 23
 Fax: (90) 216 461 74 52

www.rainbird.com
 www.rainbird.eu
 1-800-724-6247